

Color: ■ black

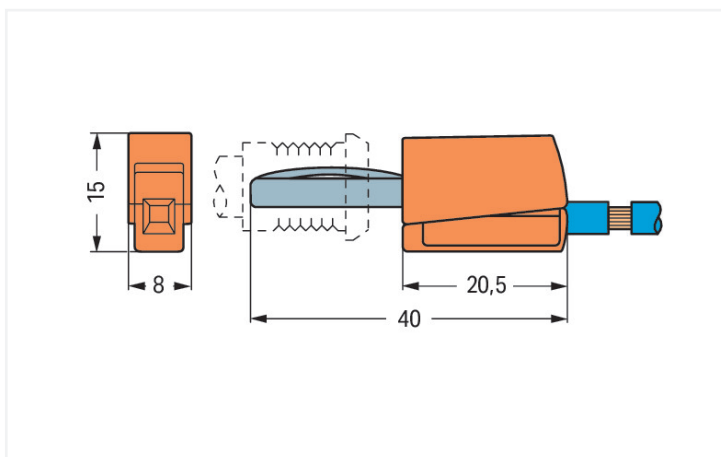

Dimensions in mm

Technical data

| | |
|----------------------------|---|
| Total number of potentials | 1 |
|----------------------------|---|

Electrical data

| | |
|---------------|------|
| Rated current | 20 A |
| Test voltage | 42 V |

Connection data

| | |
|-------------------------|--|
| Connection technology | CAGE CLAMP® |
| Strip length | 9 ... 11 mm / 0.35 ... 0.43 inches |
| Connection points | 1 |
| Solid conductor | 0.08 ... 2.5 mm ² / 28 ... 14 AWG |
| Fine-stranded conductor | 0.08 ... 2.5 mm ² / 28 ... 14 AWG |

Physical data

| | |
|--------|----------------------|
| Width | 8 mm / 0.315 inches |
| Height | 15 mm / 0.591 inches |
| Depth | 40 mm / 1.575 inches |

Material data

| | |
|-----------|----------|
| Color | black |
| Fire load | 0.041 MJ |
| Weight | 3.9 g |

Commercial data

| | |
|-----------------------|--------------------------------|
| Product Group | 2 (Terminal Block Accessories) |
| eCl@ss 10.0 | 27-44-03-13 |
| eCl@ss 9.0 | 27-44-03-13 |
| ETIM 8.0 | EC002255 |
| ETIM 7.0 | EC002255 |
| PU (SPU) | 50 pcs |
| Packaging type | Box |
| Country of origin | DE |
| GTIN | 4045454293499 |
| Customs tariff number | 85366990990 |

Environmental Product Compliance

| | |
|------------------------|-------------------------|
| RoHS Compliance Status | Compliant, No Exemption |
|------------------------|-------------------------|

Downloads



Environmental Product Compliance

| | | | |
|--|--|--|-------------------|
| Compliance Search | | | |
| Environmental Product Compliance 215-311 | | | ↓ |

Documentation

| | | | |
|-----------------|------------|-----------------|-------------------|
| Bid Text | | | |
| 215-311 | 19.02.2019 | xml 3.02 KB | ↓ |
| 215-311 | 19.09.2017 | doc 24.50 KB | ↓ |

CAD/CAE-Data

| CAD data | CAE data |
|--|---|
| 2D/3D Models 215-311  | EPLAN Data Portal 215-311  |
| | WSCAD Universe 215-311  |

Installation Notes

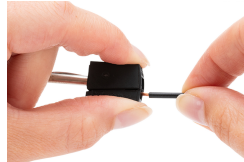
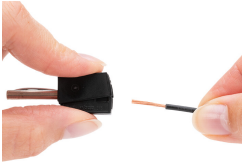

Conductor termination: Press button fully, insert stripped conductor into square entry and release.

Strip conductor to 9 ... 11 mm (0.35 ... 0.43 inch).

Testing

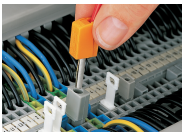

Testing via banana plug.
Picture shows a test plug adapter (Item No. 209-170).